

NT 98000

VKMA/C 98109 – VKMA 98110
 VKMA/C 98112 – VKMA/C 98114
 VKMA 98115 – VKMC 98115-2/-3/-4

Subaru

VKMA 98109

VKMC 98109

VKMA 98110

VKMA98112



VKMC 98112

VKMA 98114

VKMC 98114

VKMA 98115

VKMC 98115-2

VKMC 98115-3

VKMC 98115-4



A



(33): ST 499207100 /
 ST 499207400

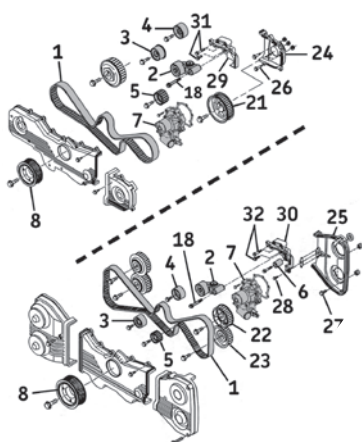

- (3)/(4)/(5)/(18): 39 Nm
- (6): 25 Nm
- (7): > 12 >> 24 Nm
- (8): > 44 >> 127 Nm (180 Nm : STI)
 / 44 Nm + 52° ± 8°
 (70° ± 5° : STI)
- (21)/(22)/(23): 78 Nm
- (26)/(27)/(28): 5 Nm
- (31)/(32): 25 Nm

Removal

- 1) Disconnect the battery according to the vehicle manufacturing guidelines.
- 2) Prepare the vehicle for the timing replacement according to the vehicle manufacturing guidelines.
- 3) Refit the crankshaft pulley bolt.
- 4) Align single markers (13), (14) and (15) (Fig. B) (single camshaft engine) or twin markers (16), (17) (Fig. C) and twin markers (14) (Fig. B) (twin camshaft engine) by turning the crankshaft in a clockwise direction using the crankshaft pulley bolt.
- 5) Remove the idler roller (3) (Fig. D and E).

Note: When the idler (3) is removed, the timing system is loosen and the LH sprockets will release its tension from the grip of the timing belt teeth and will release from its position (twin camshaft engine).

- 6) Remove the timing belt (1) (Fig. D and E).
- 7) Remove the idler rollers (4) and (5) (Fig. D and E).
- 8) Remove the bolt (18) and the tensioner roller (2) (Fig. F).
- 9) Remove the idler roller (6) (Fig. E) (twin camshaft engine).
- 10) **Removing the water pump (VKMC 98109/-2/-3 or VKMC 98112 or VKMC 98114 or VKMC 98115-2/-3/-4):**
 - Bleed the cooling circuit, check it is clean, and clean if required.
 - After disconnecting its connector, remove the camshaft angle sensor (Fig. H) (twin camshaft engine).
 - Support the left camshaft sprocket(s) (21) or (22) and (23) (depending on the type of engine) (Fig. A) using the tool (33) in order to remove its/their fixing bolt.
 - Remove the left-hand camshaft sprocket(s) (21) or (22) and (23) (Fig. A).
 - Remove the left-hand timing cover (24) or (25) and its 3 bolts (26) or its 2 bolts (27) and its bolt (28) (depending on the type of engine) (Fig. A).
 - Remove the support (29) or (30) of the tensioning roller (2) and its 3 fixing bolts (31) or (32) (depending on the type of engine) (Fig. A).
 - Disconnect the water pump (7) hoses (Fig. A).
 - Remove the six water pump fixing bolts (Fig. I).
 - Remove the water pump (7) and its seal (Fig. A).

B

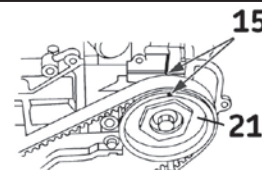
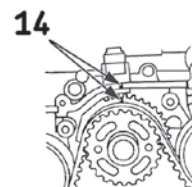
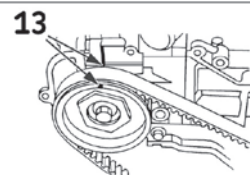

Refitting

Caution! Clean the bearing surfaces of the rollers.

- 11) Refitting the water pump:
 - Fit the new water pump (7) and its new seal and initially tighten its 6 fixing bolts to 12 Nm, then afterwards to 24 Nm, in the alphabetical order shown (Fig. I).
 - Check that the water pump pulley runs properly, and has no hard or locking spots.
 - Re-connect the water pump hoses.
 - Refit the support (29) or (30) of the tensioning roller (2) and tighten its 3 fixing screws (31) or (32) (depending on the type of engine) to 25 Nm (Fig. A).

Install Confidence



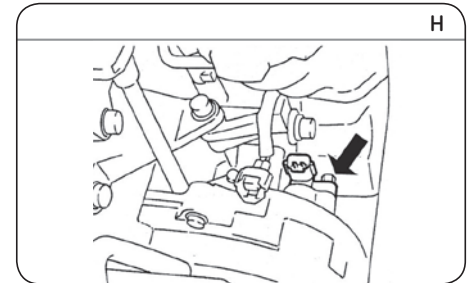
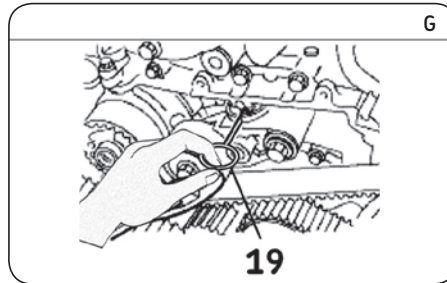
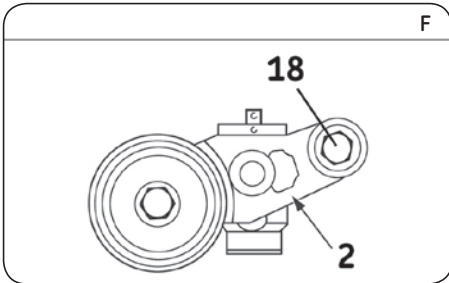
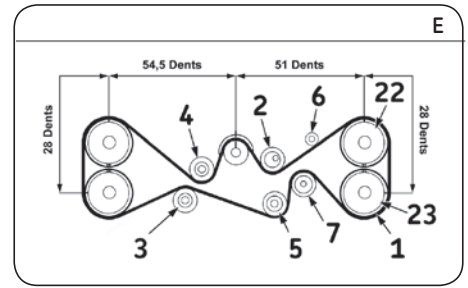
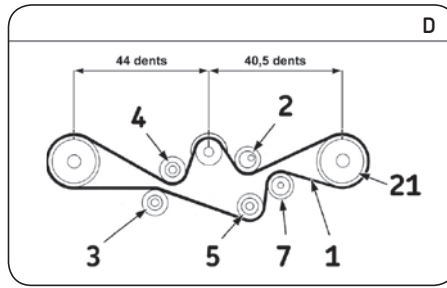
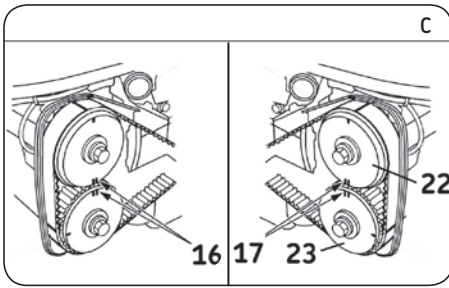

- Refit the left-hand timing cover (24) or (25) and tighten its 3 fixing bolts (26) or its 2 fixing bolts (27) and its fixing bolt (28) (depending on the type of engine) to **5 Nm** (Fig. A).
- Refit the left-hand camshaft sprocket(s) (21) or (22) and (23) whilst aligning single markers (15) (Fig. B) or twin markers (17) (Fig. C) (depending on the type of engine).
- Support the left-hand camshaft sprocket(s) (21) or (22) and (23) (depending on the type of engine) (Fig. A) using the tool (33) to tighten its or their fixing bolt to **78 Nm**.
- Refit the camshaft angle sensor and tighten its fixing bolts to **6.4 Nm** (Fig. H), then re-connect its connector (twin camshaft engine).

idler (4), to crankshaft sprocket then to the tensioner (2). Follow by the need to use Allen key or spanner/hex head (depending on assembly) to hold the upper LH camshaft sprocket (22) and turn it in **clockwise** direction to align downward its twin markers (17) (Fig. C). After the belt is wrapped around the upper LH sprocket (22) (clip to the sprocket, with an appropriate tool, to prevent running off), rotate the lower LH camshaft sprocket (23) in an anti-clockwise direction to align upward its double markers (17) with the ones of the camshaft sprocket (22) (Fig. C) and wrap the belt over and through then to the water pump and rest of the system.

- 12) Fit the new tensioning roller (2) and tighten its new fixing bolt (18) to **39 Nm** (Fig. F).
- 13) Fit the new idler rollers (4) and (5) and tighten their fixing bolts to **39 Nm** (Fig. D and E).

Note: For SOHC engines, idler roller (4) is VKM 88000 (double-row bearing) and idler roller (3) is VKM 88004 (single-row bearing) for VKMA/VKMC 98109 series. For DOHC engines, (3) and (4) = VKM 88000.

- 14) Check the alignment of the markers (13), (14) and (15) (Fig. B) (single camshaft engine) or (16), (17) (Fig. C) and (14) (Fig. B) (twin camshaft engine).
- 15) Fit the new timing belt (1) in the correct direction of rotation and with the correct number of teeth between the sprockets and the crankshaft sprocket (Fig. D or E), in the following order:
 - For single camshaft engine: crankshaft sprocket, tensioning roller (2), idler roller (4), right-hand camshaft sprocket, left-hand camshaft sprocket (21), water pump (7) and idler roller (5) (Fig. B).
 - For twin camshaft engine: wrap the timing belt (1) from the RH camshaft sprockets to

- Caution!** Offsetting the timing belt (1) by just a single tooth may result in a valve making contact with a piston.
- 16) Lift the strand of the belt (1) between the idler roller (5) and the right-hand camshaft sprocket and fit the new idler roller (3), tightening its fixing bolt to **39 Nm** (Fig. D and E).
 - 17) Fit the new idler roller (6) and tighten its fixing bolt to **25 Nm** (Fig. E) (twin camshaft engine).
 - 18) Re-check the alignment of the markers (13), (14) and (15) (Fig. B) (single camshaft engine) or (16) and (17) (Fig. C) and (14) (Fig. B) (twin camshaft engine).
 - 19) Withdraw the immobilisation pin (19) from the tensioner (2) (Fig. G).
 - 20) Rotate the crankshaft 2 rounds **clockwise** to disperse the tensioning around the system.
 - 21) Refit all components previously removed in the reverse order to that used for removal.
 - 22) For the crankshaft pulley (8) (Fig. A):
 - Initially tighten its fixing bolt to **44 Nm**, then afterwards to **127 Nm** (**180 Nm** for the STI engine), checking that the tightening angle of the bolt is greater than **45°** (**65°** for the STI engine),

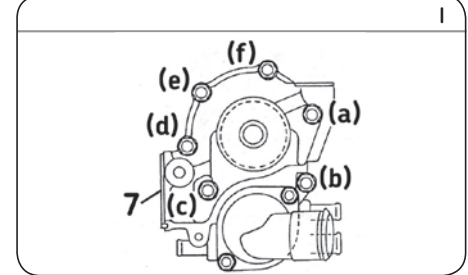

- If it is not, fit a new bolt and first tighten it to **44 Nm** and afterwards by 45 to 60° (65 to 75° for the STI engine).
- 23) Fill the cooling circuit with the permanent fluid recommended.
 - 24) Check the circuit's leak-tightness when the engine reaches its running temperature and secure the level of coolant when the engine is at ambient temperature (20 °C).

Notice: Always follow the vehicle manufacturer instructions when working on the engine. The SKF KITS are designed for the automotive repair professional and must be fitted using tooling used by these professionals. These instructions are to be used as a guideline only. This document is the exclusive property of SKF. Any representation, partial or full reproduction, is forbidden without prior written consent from SKF.